

MA-47

[®]**WESTERMO**

INSTALLATIONSANVISNING INSTALLATION MANUAL INSTALLATIONS ANLEITUNG

6047-2002

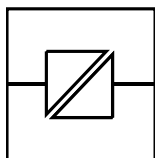

Galvanic
Isolation

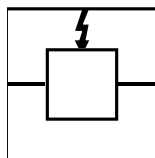

Transient
Protection

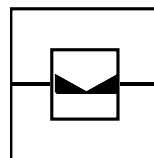

Balanced
Transmission

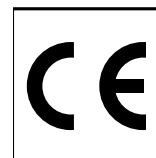

CE
Approved

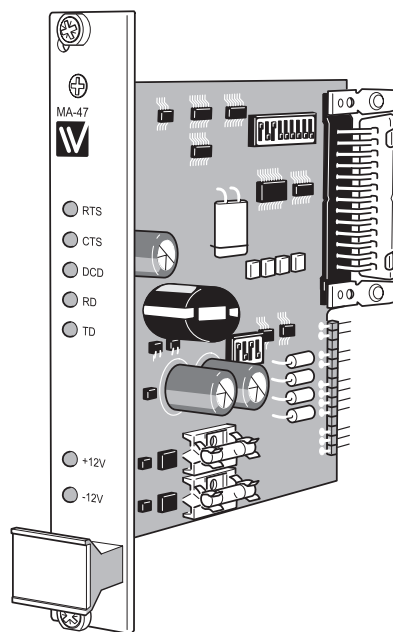

Omvandlare, RS-232 – RS-422/485
Converter, RS-232 – RS-422/485
RS-232 – RS-422/485 Wandler

 **westermo**[®]
www.westermo.se

Specifications MA-47

Transmission:	Asynchronous, full/half duplex or simplex
Interface 1:	EIA RS-232-C/CCITT V.24/V.28 25-position D-sub female, DCE
Interface 2:	EIA RS-422/RS-485/CCITT V.11
Data rate:	Up to 38.4 Kbit/s
Indicators:	Power, RD, DCD, CTS, RTS, TD
Insulation:	Galvanic insulation with opto-coupler (data transmission) and transformer (supply)
Insulation voltage:	1500V
Overvoltage protection:	Breakdown voltage transmitter and receiver 7V. Surge capacity 0.6 kW for 1ms.
Power supply:	External through PS-02 mounted in rack RV-01. $\pm 20\text{VDC} \pm 20\%$
Fuse:	2 pcs 100 mA fast 5x20mm
Power consumption:	+20V 70mA, -20V 45mA
Temperature range:	5–50°C, ambient temperature
Humidity:	0–95% RH, non-condensing
Dimensions:	100x100mm
Weight:	0.1 kg
Mounting:	To be mounted in rack RV-01, takes one card slot.

Switch settings

The MA-47 can through different switch settings be adapted to a variety of running conditions.

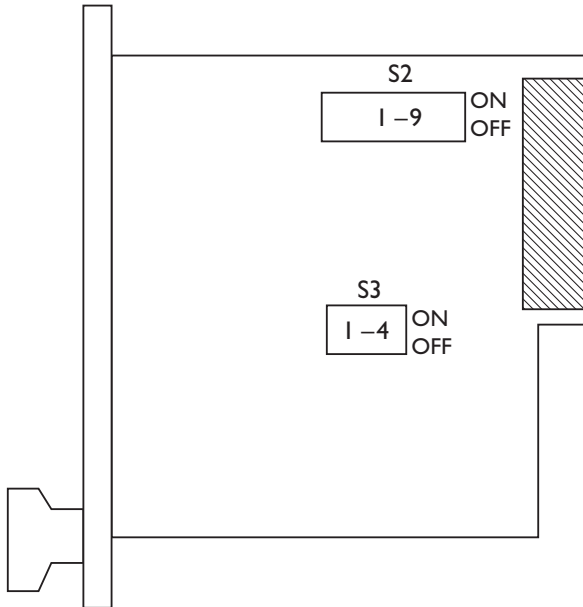

- S2 Selection of data rate
Selection of 2- or 4-wire transmission
Selection of no. of data bits
(see table below)
- S3 Selection of termination
and fail-safe)

Selection of data rate

S2		300 bit/s
S2		600 bit/s
S2		1200 bit/s
S2		2400 bit/s
S2		4800 bit/s
S2		9600 bit/s
S2		19200 bit/s
S2		38400 bit/s

Selection of bits

S2		9
S2		10
S2		11
S2		12

2/4-wire transmission

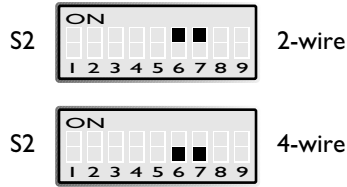

Factory settings

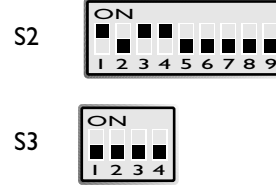

S1: 8-9 not in use

Termination with fail-safe

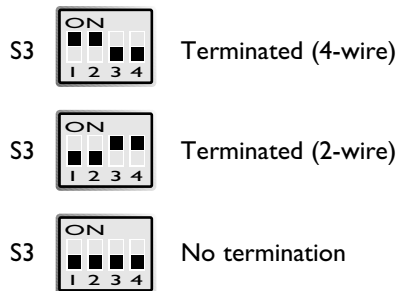

The fail-safe function forces the signal state of the receiver to OFF when the connected transmitter is in tri-state (transmitter inactive). The receiver located furthest away shall be terminated.

Supervision table when selecting data bits

7 bits	●	●	●		●			
8 bits				●		●	●	●
No parity	●	●		●		●		
Parity			●		●		●	●
1 stop bit	●		●	●			●	
2 stop bits		●			●	●		●
Number of bits	9	10	10	10	11	11	11	12

Connections

Line connection

(5-Position screw-terminal)

Direction	Pin no.	CCIT V.11 Description
Receiver	1	A' (R+)
Receiver	2	B' (R-)
Transmitter	3	A (T+)
Transmitter	4	B (T-)
		Shield

The definitions R+/R-, T+/T- can be various between different manufactures.

Look right for a section of rack RV-01 with one MA-47 mounted.

Terminal connection to a 25-position D-sub(female) connector on MA-47.

Line connection to a 5-position detachable screw-terminal, which is mounted on the male connector located at the rear of RV-01.

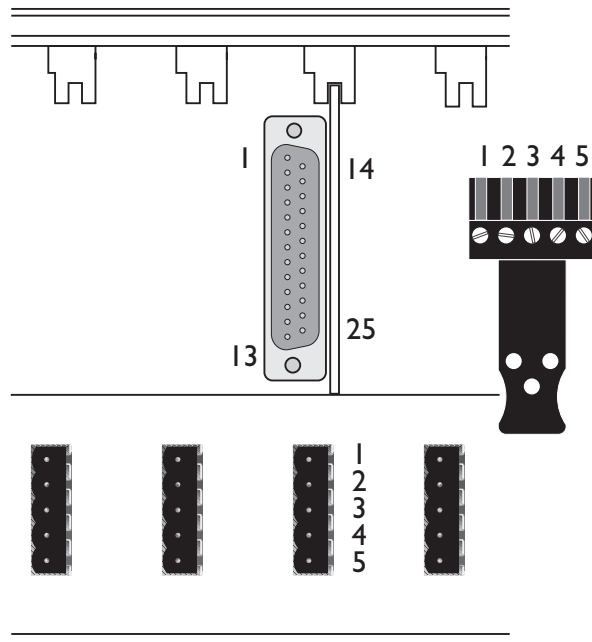

Terminal connection (DCE)

(RS-232-C/V.24/V.28, 25-Polig D-sub, female)

Direction	Connection	CCITT V.24 Code	Signal name
I	2	103	TD/Transmitted Data
O	3	104	RD/Received Data
I	4	105	RTS/Request To Send
O	5	106	CTS/Clear To Send
O	6	107	DSR/Data Set Ready
-	7	102	SG/Signal Ground
O	8	109	DCD/Data Carrier Detect
I	20	108/2	DTR/Data Terminal Ready

I = Input O = Output on MA-47

Line connection

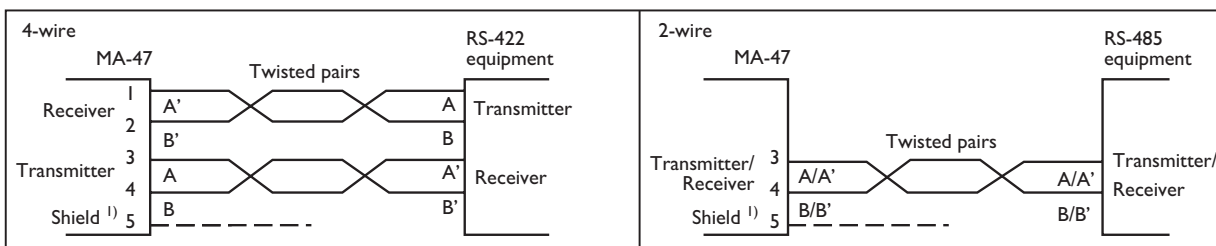

1) If shielded cable is used, connect the shield only at one end to avoid ground currents.

Transmission range (interface 2)

Use twisted pair cable. Max transmission range 1200 m.

(cable specifications 0.3mm² and capacitance 42pF/m).

The transmission range will increase if a cable with lower capacitance and larger diameter is used.

Use shielded cable in heavy industrial environments.

Hints

The MA-47 uses the RS-422/485 interface. RS-422/485 was designed for multidrop applications. When a system is installed it should form a bus structure (see diagrams). Star shaped networks should never be created, there are other Westermo products designed to work in star net applications. To install correctly, an RS-422/485 network should be terminated at the correct points. The recommendation is to terminate the receiver on the master unit and the final bus slave unit. See diagrams for details of how this is done with RS-485 (2 wire) and RS-422 (4 wire).

The line transmitter used in the MA-47 is activated by data received on the RS-232 interface, unlike conventional converters that rely on a control signal (e.g. RTS).

If any problems do occur on set up of the MA-47, the LED's will be helpful.

- PWR: The unit has power.
- RD: Data received on the RS-422/485 interface.
- DCD: Follows RD in two wire operation. Always active for four wire.
- CTS: Follows RTS
- RTS: Status of RTS from the RS-232 interface
- TD: Data received on RS-232 interface

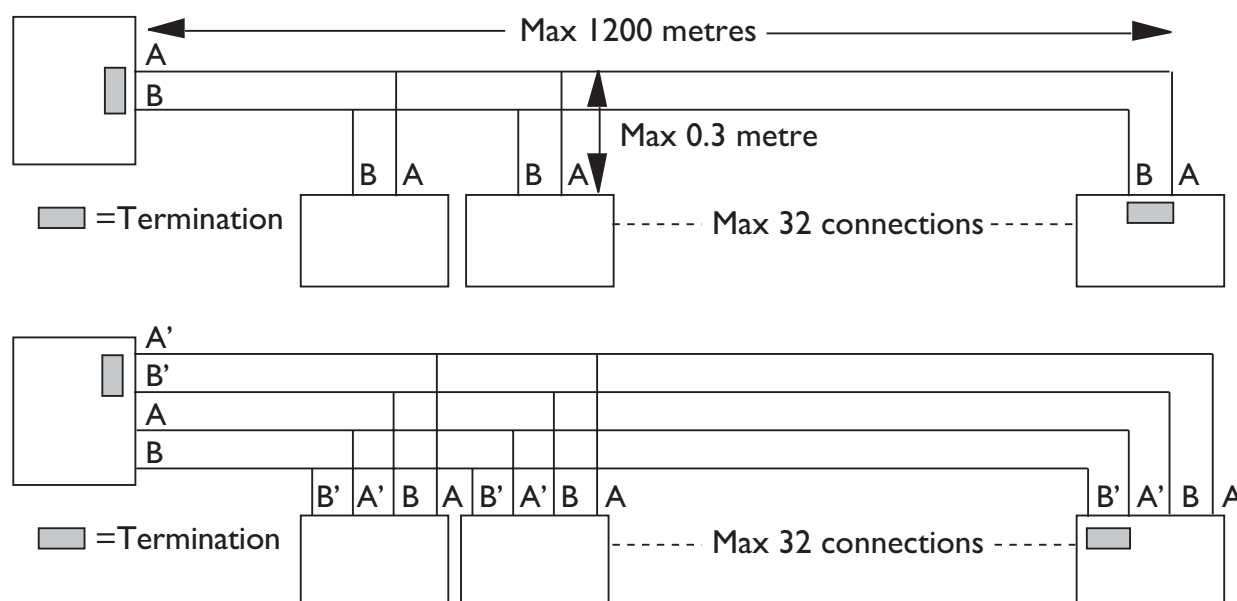

N.B. R+/R-, T+/T- definitions are not standard, it can help to shift A and B if the unit does not work.

Block diagram

V.24/RS-232

V.11/RS-422
RS-485

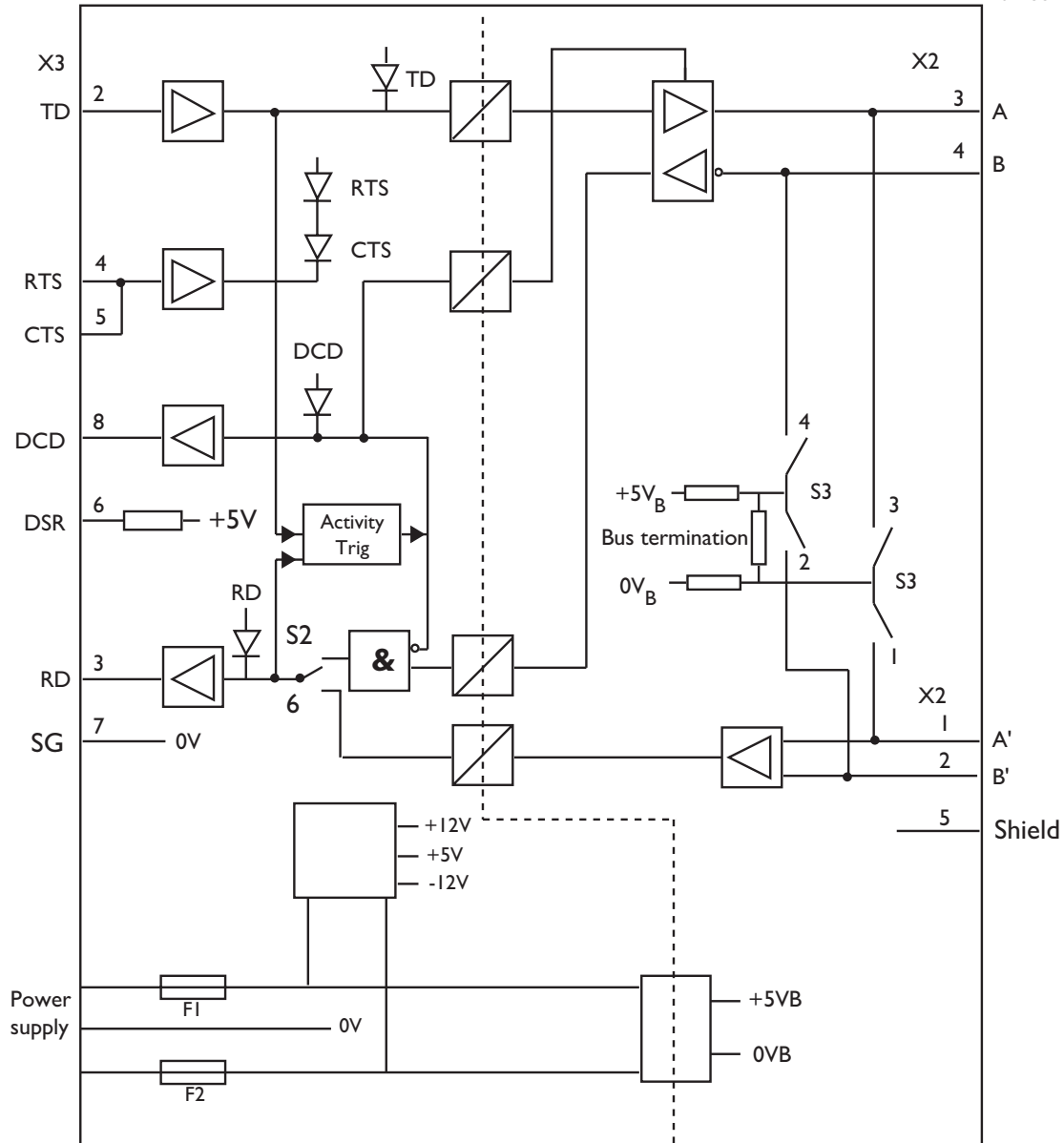

Westermo Teleindustri AB have distributors in several countries,
contact us for further information.



Westermo Teleindustri AB • S-640 40 Stora Sundby, Sweden

Phone +46 16 612 00 Fax +46 16 611 80

E-mail: info@westermo.se • Westermo Web site: www.westermo.se

Subsidiaries

Westermo Data Communications Ltd
Solent Business Centre • Millbrook Road West
Millbrook, Southampton • SO15 0HW
Phone: +44(0)2380 704 611 • Fax: +44(0)1703 702 682
E-Mail: sales@westermo.co.uk

Westermo Data Communications GmbH
Bruchsaler Straße 18, 68753 Waghäusel
Tel.: +49(0)7254-95400-0 • Fax: +49(0)7254-95400-9
E-Mail: westermo.germany@t-online.de