

LD-01 AC  
LD-01 DC

# INSTALLATIONSANVISNING INSTALLATION MANUAL INSTALLATIONS ANLEITUNG

6154-2001

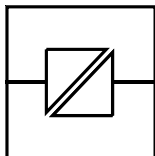

Galvanic  
Isolation

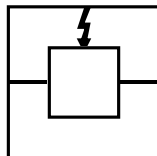

Transient  
Protection

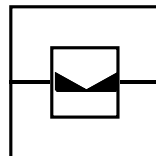

Balanced  
Transmission

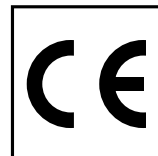

CE  
Approved

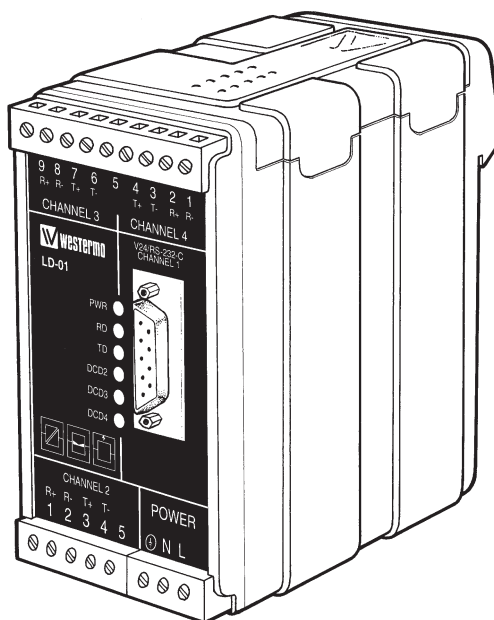

*Linjedelare  
Line Split Unit  
Leitungsteiler*

 **westermo**<sup>®</sup>  
www.westermo.se

<sup>®</sup>  
**WESTERMO**

## Specifications LD-01

<b>Transmission</b>	Asynchronous, full/half duplex or simplex
<b>Interface 1</b>	EIA RS-232-C/V.24 fixed on channel 1, selectable on channel 2 and 3
<b>Interface 2, (WI)</b>	10 mA balanced current loop fixed on channel 4, selectable on channel 2 and 3
<b>Connection</b>	<b>Channel 1:</b> 9 pin D-sub female <b>Channel 2:</b> 5 pos screw-terminal <b>Channel 3, 4:</b> 9 pos screw-terminal
<b>Transmission rate</b>	Data rates up to 38.4 Kbit/s
<b>Indicators</b>	Power <b>Channel 1:</b> RD, TD <b>Channel 2–4:</b> DCD
<b>Isolation</b>	Galvanic isolation with opto-coupler (Interface 2) and transformer (supply) Interface 1 only isolation against supply
<b>Isolation voltage</b>	1500V
<b>Oversvoltage protection</b>	<b>Mains:</b> Breakdown voltage 430V at 230V AC and 230V at 115V AC* Breakdown voltage transmitter 15V, receiver 5.8V Surge capacity 0.6 kW during 1 ms
<b>Power supply</b>	115V*/230V AC 48–62Hz +15/–10%
<b>Fuse</b>	100 mA fast 5x20 mm
<b>Power consumption</b>	Max 4VA at 115V*/230V AC
<b>Temperature range</b>	5–50°C, ambient temperature
<b>Humidity</b>	0-95% RH, non-condensing
<b>Dimension</b>	55x100x128 mm (WxHxD)
<b>Weight, kg</b>	AC 0,5 / DC 0,3
<b>Mounting</b>	On DIN-rail 35 mm

\* LD-01 115V AC only

## Switch settings

The LD-01 can through different switch settings be adapted to a variety of running conditions. To set the switches, open the lid on the top of the plastic case.

**WARNING!**  
**DO NOT OPEN CONNECTED UNIT**

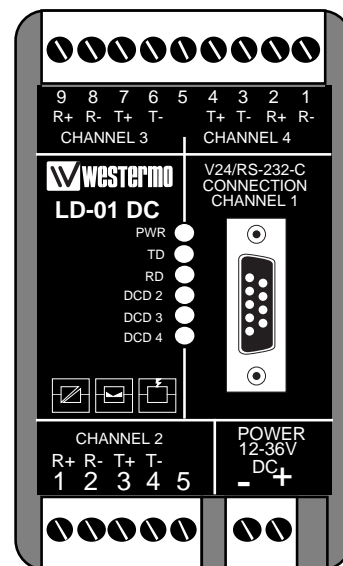
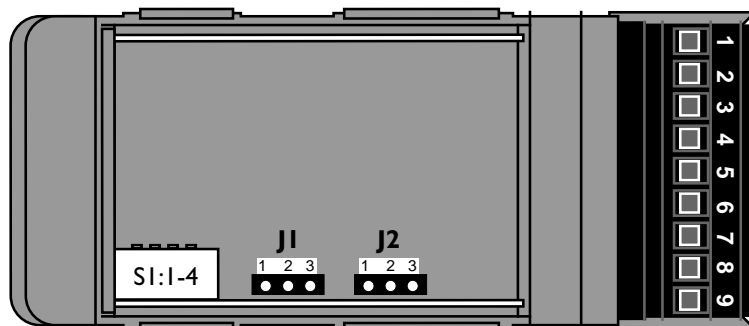

### RS-232-C/V.24 or WI, Channel 2

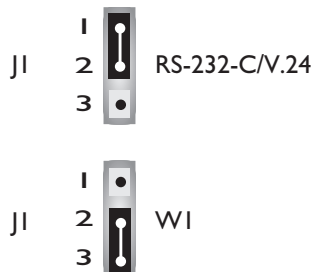

### RS-232-C/V.24 or WI, Channel 3

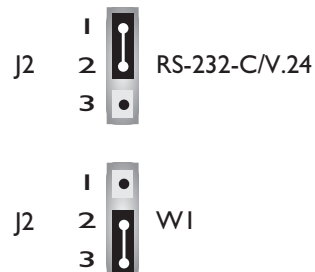

### V or Y function

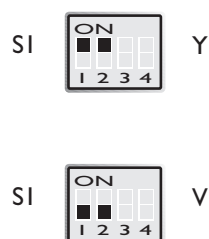

SI:3 and 4 not used  
See functional description

### Factory settings

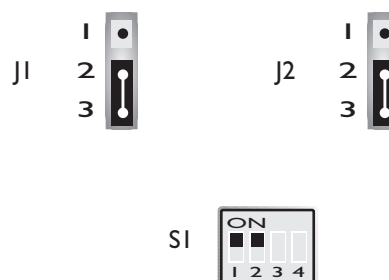

# Connections

## Connection RS-232-C/V.24

Direction DCE	RS-232-C/V.24			CCITT V.24 Circuit no.	Description
	Channel 1	Channel 2	Channel 3		
O	1	4	6	109	DCD/Data Carrier Detect
O	2			104	RD/Received Data
I	3			103	TD/Transmitted Data
I	4			108/2	DTR/Data Terminal Ready
-	5	5	5	102	SG/Signal Ground
O	6			107	DSR/Data Set Ready
I	7			105	RTS/Request To Send
O	8			106	CTS/Clear To Send
NC	9				

I = Input O = Output, the LD-01 is a DCE (Data Communication Equipment) NC = Not connected  
 □ = the signals are only connected with each other.

## Power connection (AC)

(3-position screw-terminal)

Screw no.	Power Supply
N L	115V*/230V AC power
	PE/Protective Earth

\* LD-01 115V only

## Line connection

Direction	Pin configuration 10mA balanced current loop			Signal name
	Channel 2	Channel 3	Channel 4	
Receiver	1	9	2	R+
Receiver	2	8	1	R-
Transmitter	3	7	4	T+
Transmitter	4	6	3	T-
	5	5	5	I) Shield

I) If shielded cable is used, connect the shield only at one end to avoid ground currents.

## Transmission range (10mA balanced current loop WI)

Cable	Transmission data rate bit/s						
	42pF/m 0,3mm <sup>2</sup>	600	1200	2400	4800	9600	19200
	18000m	12000m	8000m	5000m	2500m	1000m	500m

## LD-01 DC

### Specifications

**Power supply** 12–36V DC, 36–55V DC\*

**Power consumption** Max 3W

**Insulation** 1000V

**Fuse FI** 1.6 A fast 5x20 mm

\* LD-01 DC, 36–55V DC only

All other specifications according to LD-01 AC

### Switch settings

According to LD-01 AC

### Connections

According to LD-01 AC, except power supply

Connection no	Power Supply
1	– Voltage
2	+ Voltage

## Hints

LD-01 has four channels. Channel 1 has RS-232 interface and channel 2 and 3 can be configured as RS-232 or WI interface. Channel 4 has only WI interface. The LD-01 splits the line and repeats the signal in a multidrop system. The maximum number of units in serial connection is 14 units.

The drop channel (no 1) is configured as DCE (Data Communication Equipment). Most printers, PC's and terminals are set as DTE (Data Terminal Equipment). A recommendation of cable configurations is given below.

If any problems do occur on set up of the LD-01:s, the LED's may be helpful.

- PWR: The unit has power.
- RD channel 1: Indicates transmitted data from channel 1
- TD channel 1: Indicates received data on channel 1
- DCD channel 2: Indicates that WI is connected to channel 2
- DCD channel 3: Indicates that WI is connected to channel 3
- DCD channel 4: Indicates that WI is connected to channel 4

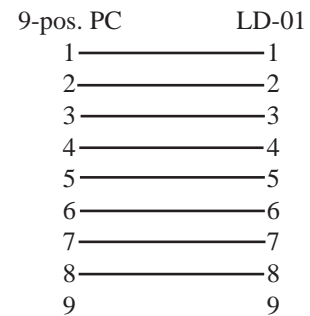
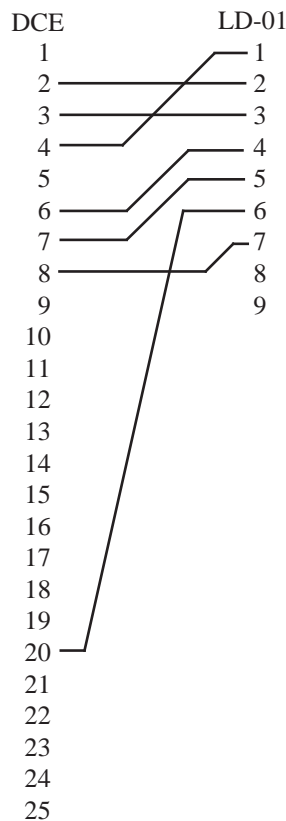
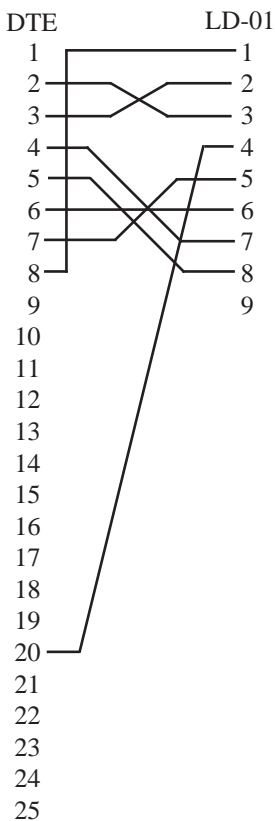

**OWN COMMENTS**

.....

.....

.....

.....

.....

.....

.....

.....

.....

.....

.....

.....

.....

.....

.....

.....

.....

.....

.....

.....

.....

## Functional Description

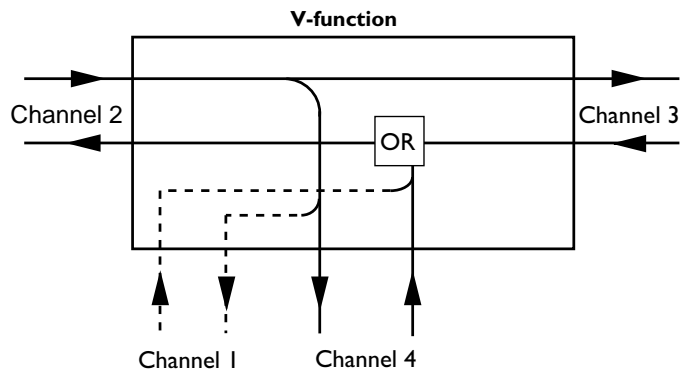

Communication between master and slaves.

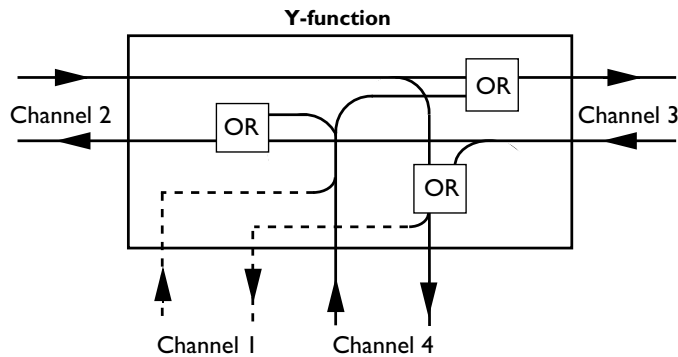

Communication between all connected units.

Westermo Teleindustri AB have distributors in several countries,  
contact us for further information.



Westermo Teleindustri AB • S-640 40 Stora Sundby, Sweden

Phone +46 16 612 00 Fax +46 16 611 80

E-mail: [info@westermo.se](mailto:info@westermo.se) • Westermo Web site: [www.westermo.se](http://www.westermo.se)

### Subsidiaries

Westermo Data Communications Ltd  
Unit 14 Talisman Business Centre • Duncan Road  
Park Gate, Southampton • SO31 7GA  
Phone: +44(0)1489 580 585 • Fax: +44(0)1489 580586  
E-Mail: [sales@westermo.co.uk](mailto:sales@westermo.co.uk) • Web: [www.westermo.co.uk](http://www.westermo.co.uk)

Westermo Data Communications GmbH  
Bruchsaler Straße 18, 68753 Waghäusel  
Tel.: +49(0)7254-95400-0 • Fax.: +49(0)7254-95400-9  
E-Mail: [westermo.germany@t-online.de](mailto:westermo.germany@t-online.de)