

MM-14

# INSTALLATIONSANVISNING INSTALLATION MANUAL INSTALLATIONS ANLEITUNG

6186-2003

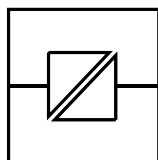

Galvanic  
Isolation

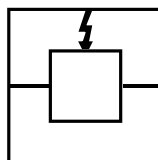

Transient  
Protection

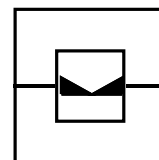

Balanced  
Transmission

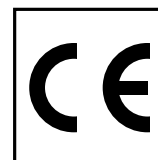

CE  
Approved

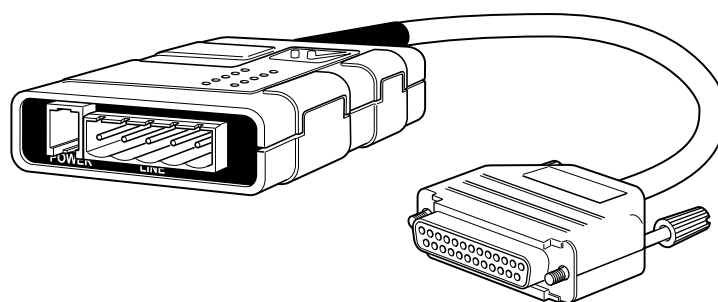

*Korthållsmodem  
Short haul modem  
Kurzstreckenmodem*

**WESTERMO**<sup>®</sup>

**WESTERMO**<sup>®</sup>  
www.westermo.se

## Specifikationer

<b>Överföring</b>	Asynkron, full/halv duplex eller simplex
<b>Gränssnitt 1</b>	EIA RS-232-C/ITU-T V.24 8-polig modular jack, RJ-45 eller 9-polig D-sub, stift/hylsa eller 25-polig D-sub, stift/hylsa omkopplingsbar mellan DCE/DTE
<b>Gränssnitt 2</b>	±10 mA balanserad strömslinga Simplex (ett tvinnat par) Full/halv duplex (två tvinnade par) 5-polig skruvplint
<b>Hastighet</b>	Upp till 38 400 bit/s
<b>Isolation</b>	Galvanisk isolation med optokopplare (dataöverföring) resp. nätadapter (matning)
<b>Isolationsspänning</b>	500 V
<b>Överspänningsskydd</b>	<b>Gränssnitt 2:</b> inbyggt transientskydd, genombrotts- spänning mottagare 5,8 V, sändare 15 V Avledningsförmåga 0,6 kW under 1 ms.
<b>Strömförsörjning</b>	<b>Alt. 1:</b> Från stift 9 och 10 i RS-232, ±12 V DC ±5% relativ signaljord <b>Alt. 2:</b> 230 V AC ±10% 48–62 Hz via nätadapter PS-8, alternativt 27–40 V DC, isolerad från gränssnitt 1
<b>Effektförbrukning</b>	<b>Alt. 1:</b> +12 V 15mA, –12 V 15 mA <b>Alt. 2:</b> Max 1,5 VA
<b>Nätadapter</b>	PS-8, 1,5 m kabel
<b>Temperaturområde</b>	5–50°C, omgivningstemperatur
<b>Fuktighetsområde</b>	0–95% RH, utan kondensation
<b>Mått mm</b>	98x60x22 (BxHxD)
<b>Vikt</b>	0,07 kg

# Inställningar

MM-14 kan genom inställningar anpassas till ett flertal olika driftförhållanden. Samtliga omkopplare i MM-14 görs åtkomliga genom att lådans lock avlägsnas. Detta sker lätt med hjälp av t ex en skruvmejsel.

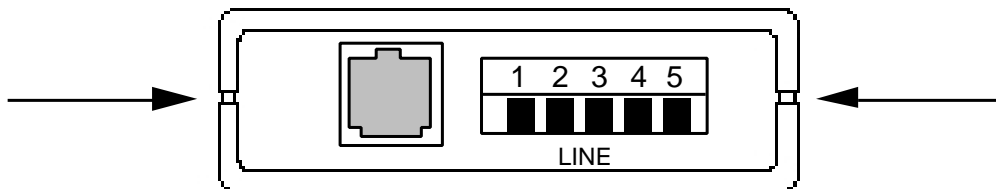

Omkopplarna är placerade och har funktion enligt beskrivning nedan:

Placering på kretskort:

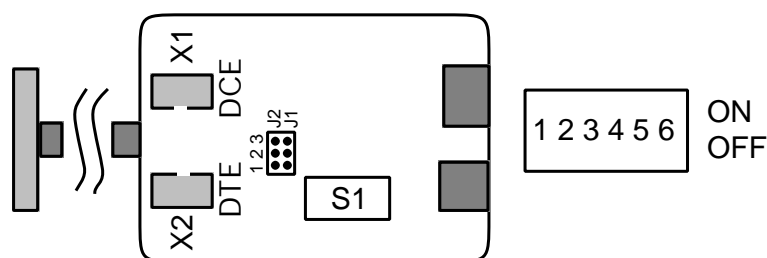

9/25-polig.  
D-sub

Funktion:

- S1 Val av kontrollsignal för aktivering av sändare (bärvåg)  
Val av signal för styrning av CTS/DTR
- X1/X2 Val av funktion DCE/DTE (Kabeln placeras i önskad kontakt)
- J1/J2 Val av intern/extern matning

### DCE Sändare (bärvåg) aktiverad av

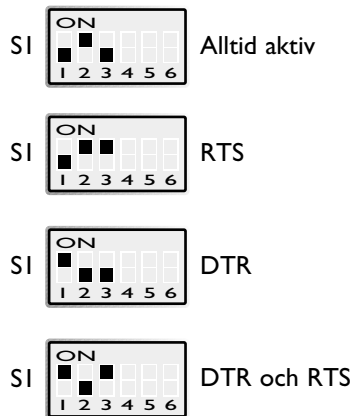

### DTE Sändare (bärvåg) aktiverad av

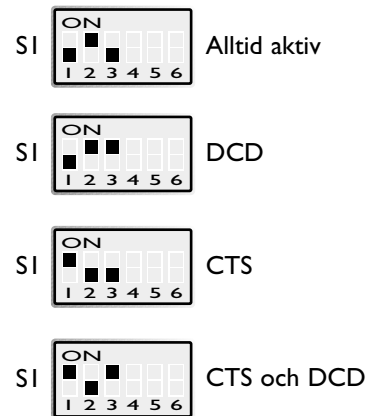

### DCE CTS styrd av

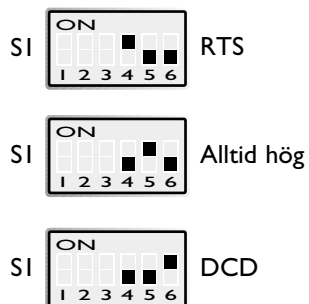

### DTE DTR styrd av

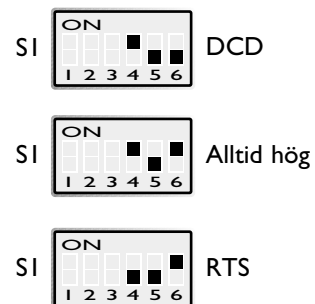

### Intern/extern matning

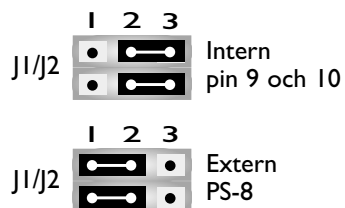

### Fabriksinställning

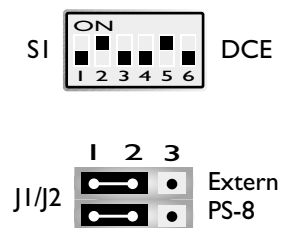

# Anslutningar

## Linjeanslutning

(5-polig skruvplint)

Riktning	Anslutning nr.	Benämning
Mottagare	1	(R+)
Mottagare	2	(R-)
Sändare	3	(T+)
Sändare	4	(T-)
	5	Skärm

## Terminalanslutning (DCE)

(RS-232-C/V.24, 25/9-Polig D-sub, hylsdon/stiftdon alt. RJ-45)

Riktning	Anslutning			ITU-T V.24 Benämning	Signalnamn
	9-pol	25-pol	8-pol		
I	3	2	6	103	TD/Transmitted data
O	2	3	5	104	RD/Received Data
I	7	4	8	105	RTS/Request To Send
O	8	5	7	106	CTS/Clear To Send
O	6	6	1	107	DSR/Data Set Ready
-	5	7	4	102	SG/Signal Ground
O	1	8	2	109	DCD/Data Carrier Detect
-	-	9	-	-	PWR +12V
-	-	10	-	-	PWR -12V
I	4	20	3	108/2	DTR/Data Terminal Ready

I = Ingång, O = Utgång på MM-14

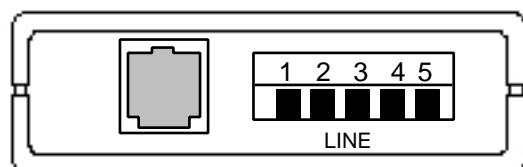

Matnings-  
anslutning  
till PS-8

Linjeanslutning  
5-polig  
skruvanslutning

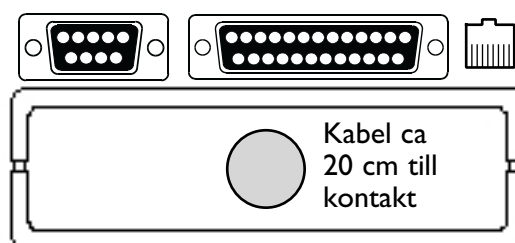

RS-232-C/V.24  
9-/25-polig D-sub  
stift eller hylskontakt  
8-polig modular jack RJ-45

# Linjekoppling

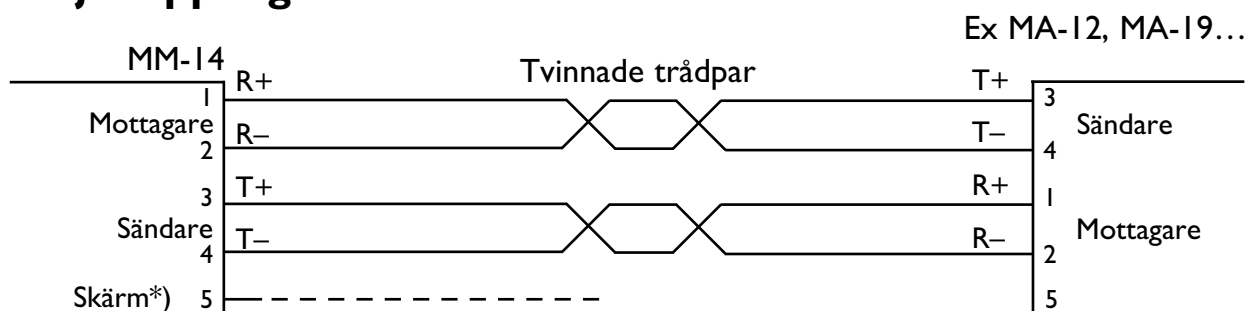

\* Om skärmad kabel används, anslut skärmen endast i en ände för att undvika jordströmmar.

## Överföringsavstånd 10 mA, WI (gränssnitt 2)

Kabel	Överföringshastighet bit/s						
	600	1 200	2 400	4 800	9 600	19 200	38 400
42pF/m 0,3 mm <sup>2</sup>	18 000 m	12 000 m	8 000 m	5 000 m	2 500 m	1 000 m	500 m

## Tips

Linjegränssnittet på MM-14 är kompatibelt med Westermo asynkrona modem.

MM-14 kan konfigureras som DCE (Data Communication Equipment), vilket är det vanliga hos kommunikationsutrustning, eller DTE (Data Terminal Equipment) via anslutning i MM-14. Dessa anslutningar gör det möjligt att använda samma kablage i både DCE och DTE applikationer.

Om det uppkommer något problem vid inkoppling av MM-14 kan några enkla felsökningstips vara till värdefull hjälp.

Ett bra sätt att testa modemmet är att ansluta den mot en terminal och samtidigt bygla linjen, T+ byglas till R+ och T- till R-. Det tecken som skickas av terminalen skall nu "ekas" tillbaka. Nästa steg är att koppla in motstående modem och bygla RD (Receive Data) och TD (Transmitted Data), tecknen skall nu ekas på samma sätt som tidigare om enheterna och linjen är riktiga.

# Specifications

<b>Transmission</b>	Asynchronous, full/half duplex or simplex
<b>Interface 1</b>	EIA RS-232-C/ITU-T V.24 8-position modular jack, RJ-45 or 9-position D-sub, male/female or 25-position D-sub, male/female switchable between DCE/DTE
<b>Interface 2</b>	$\pm 10$ mA balanced current loop Simplex (one twisted pairs) Full/half duplex (two twisted pairs) 5-position screw-terminal
<b>Transmission</b>	Up to 38.4 kbit/s
<b>Isolation</b>	Galvanic isolation with optocoupler (data transmission) and main adapter (supply)
<b>Isolation voltage</b>	500 V
<b>Overvoltage protection</b>	<b>Interface 2:</b> Transient protection, Breakdown voltage receiver 5.8 V, transmitter 15 V.
<b>Power supply</b>	Surge capacity 0.6 kW during 1ms. <b>Alt. 1:</b> From terminals pin 9 and 10 $\pm 12$ V DC $\pm 5\%$ relative signal earth <b>Alt. 2:</b> 230 V AC $\pm 10\%$ 48–62 Hz via main adapter PS-8. alternative 27–40 V DC, isolated from interface 1
<b>Power consumption</b>	<b>Alt. 1:</b> +12 V 15 mA, –12 V 15 mA <b>Alt. 2:</b> Max 1.5 VA
<b>Main adapter</b>	PS-8, 1.5 m cable
<b>Temperature range</b>	5–50°C
<b>Humidity</b>	0–95% RH, non-condensing
<b>Dimension</b>	98x60x22 (WxHxD)
<b>Weight</b>	0.07 kg



## Switch settings

The MM-14 can through different switch settings be adapted to a variety of running conditions. To set the switches, open the plastic case by placing and turning a screw-driver between top and bottom at the rear of the case.

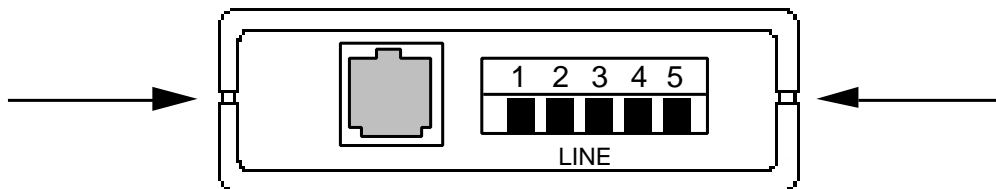

On the circuit board the switches has the following location and functions:

Location on circuit board:

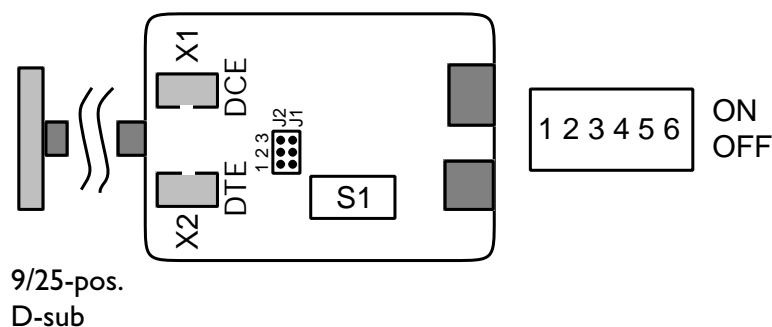

Function:

- SI Selection of signal activating transmitter (carrier)  
Selection of signal controlling CTS/DTR
- X1/X2 Selection of function DCE/DTE  
(The cable is placed in required connector)
- J1/J2 Selection of internal/external power supply

**DCE  
Transmitter (carrier)  
activated by**

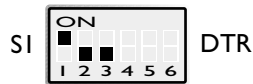
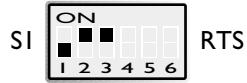

**DTE  
Transmitter (carrier)  
activated by**

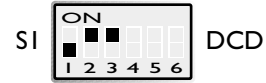

**DCE  
CTS controlled by**



**DTE  
DTR controlled by**

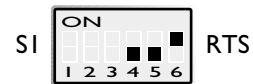

**Internal/external  
supply**

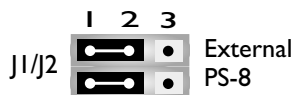
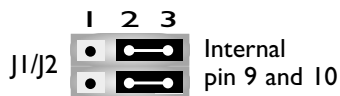

**Factory settings**

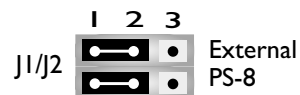
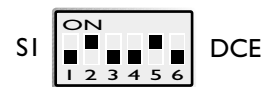

# Connections

## Line connection

(5-position screw-terminal)

Direction	Pin no.	Description
Receiver	1	(R+)
Receiver	2	(R-)
Transmitter	3	(T+)
Transmitter	4	(T-)
	5	Shield

## Terminal connection (DCE)

(RS-232-C/V.24, 25/9-pos D-sub, male/female or RJ 45)

Direction	Connection no.			ITU-T V.24 Description	Description
	9-pos	25-pos	8-pos		
I	3	2	6	103	TD/Transmitted data
O	2	3	5	104	RD/Received Data
I	7	4	8	105	RTS/Request To Send
O	8	5	7	106	CTS/Clear To Send
O	6	6	1	107	DSR/Data Set Ready
-	5	7	4	102	SG/Signal Ground
O	1	8	2	109	DCD/Data Carrier Detect
-	-	9	-	-	PWR +12V
-	-	10	-	-	PWR -12V
I	4	20	3	108/2	DTR/Data Terminal Ready

I = Input, O = Output on MM-14

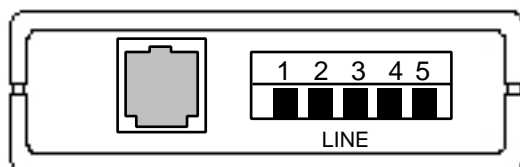

Supply connection to PS-8

Line connection 5-position screw-terminal

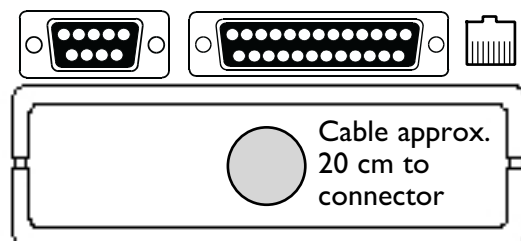

RS-232-C/V.24  
9-/25-position D-sub  
male or female connector  
8-position modular jack RJ-45

## Line connection

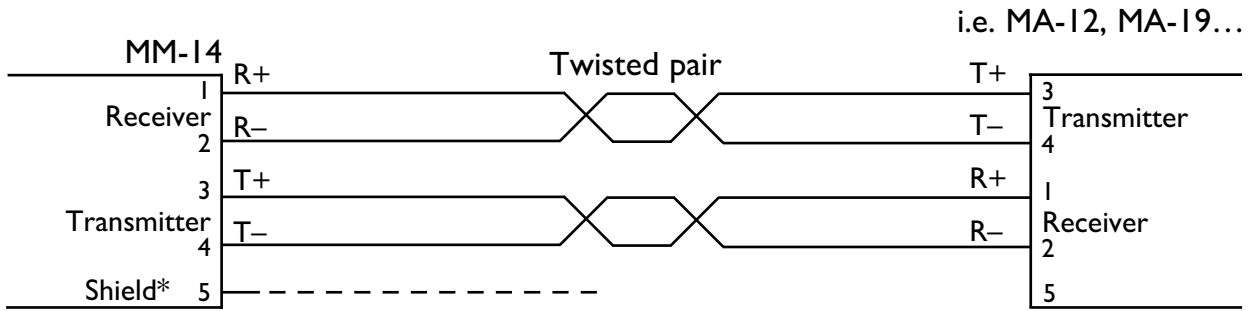

\* If shielded cable is used, connect the shield only at one end to avoid ground currents.

## Transmission range 10 mA, WI (interface 2)

Cable	Transmission rate bit/s						
	600	1 200	2 400	4 800	9 600	19 200	38 400
42pF/m 0.3 mm <sup>2</sup>	18 000 m	12 000 m	8 000 m	5 000 m	2 500 m	1 000 m	500 m

## Hints

The MM-14 has the same line interface as many of Westermo's systems and are hence compatible.

The RS-232/V.24 interface on the MM-14 can be configured as DCE (Data Communication Equipment) or as DTE (Data Terminal Equipment) via connectors inside the MM-14. Those connectors makes it possible to use the same cable in both DCE and DTE applications.

If any problems do occur on set up of the MM-14, some hints will be helpful.

A good way to check the MM-14 is to carry out a loop back test. Connect T+ to R+ and T- to R-. Connect the RS-232/V.24 port to a terminal. When keys are pressed on the terminal you should receive the echo on screen. If this test is ok then connect the remote modem and make a loop between RD (*Received Data*) and TD (*Transmitted Data*), the characters transmitted from the terminal shall be echoed in the same way as before.

## Technische Daten

<b>Übertragungsarten</b>	Asynchron, Voll-/Halbduplex oder Simplex
<b>Schnittstelle 1</b>	EIA RS-232-C/ITU-T V.24 8 polige RJ-45 Buchse oder 9 polige Sub-D-Buchse / Stecker oder 25 polige Sub-D-Buchse / Stecker schaltbar DÜE/DEE
<b>Schnittstelle 2</b>	±10mA Symmetrische Stromschleife Simplex (auf 2-Draht) oder Halb- Vollduplex auf 4-Draht 5 polige Schraubklemme
<b>Übertragungsraten</b>	Bis zu 38 400 Bit/s
<b>Isolation</b>	Galvanisch Isoliert mittels Optokoppler (Datenübertragung) und Transformator (Spannungsversorgung)
<b>Isolationsspannung</b>	500 V
<b>Überspannungsschutz</b>	<b>Schnittstelle 2:</b> Transienten geschützt, Durchbruchspannung Sender 15V und Empfänger 5,8V
<b>Spannungsversorgung</b>	Stromstosskapazität 0,6 kW/1mS 1.) Über Terminal Pin 9 & 10 ± 12 V DC ± 5% bezogen auf Signalerde 2.) 230 V +15/-10% 48-62 Hz über PS-08 Adapter alternativ 27-40V DC, isoliert von Schnittstelle 1
<b>Leistungsaufnahme</b>	1.) +12 V 15 mA, -12 V 15 mA 2.) Max 1,5 VA
<b>Netzadapter</b>	PS-8, 1,5 m Anschlußkabel
<b>Umgebungstemperatur</b>	5–50°C
<b>Luftfeuchtigkeit</b>	0–95%, nicht kondensierend
<b>Abmessungen</b>	98x60x22 mm (BxHxT)
<b>Gewicht</b>	0,07 kg

## DIP-Schalter Einstellung

Das MM-14 bietet verschiedene Einstellmöglichkeiten zur Abstimmung auf verschiedenste Betriebsverhältnisse. Um die DIP-Schalter einzustellen muß die Gehäuseabdeckung z.B. mit Hilfe eines Schraubendrehers abgenommen werden.

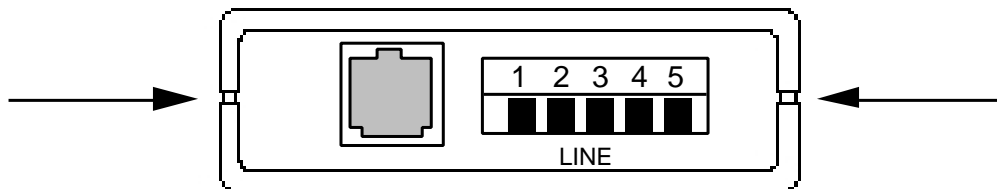

Auf der Platine sind die haben die DIP-Schalter folgende Lage und Funktionen:

Lage auf der Platine:

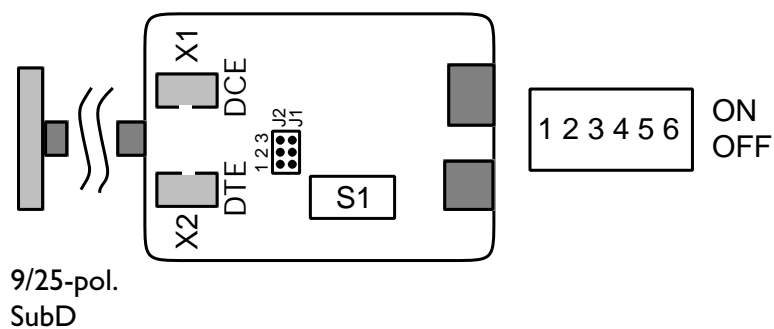

Funktion:

- SI Auswahl des Aktivierungssignal des Senders (Träger)
- Auswahl des Signals welches CTS/DTR steuert
- X1/X2 Auswahl DEE/DÜE
- J1/J2 Einstellung interne/externe Spannungsversorgung

### DÜE Sender (Träger) aktiviert durch

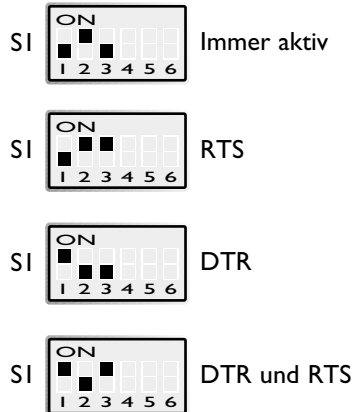

### DEE Sender (Träger) aktiviert durch

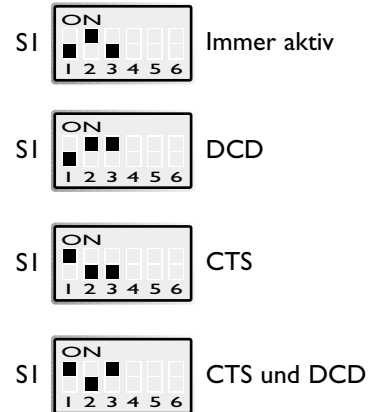

### DÜE CTS gesteuert von

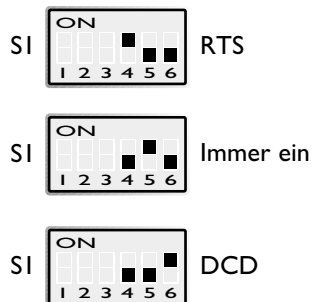

### DEE DTR gesteuert von

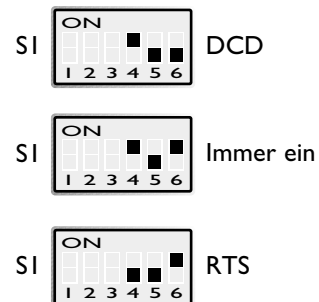

### Interne/externe Versorgung

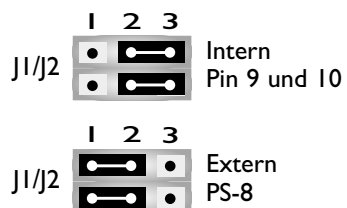

### Werkseinstellung

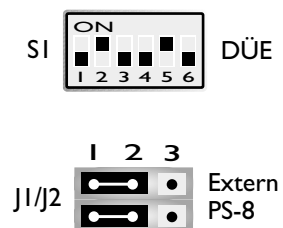



# Leitungsanschluß

(5-polige Schraubklemme)

Richtung	Nr.	Beschreibung
Empfänger	1	(R+)
Empfänger	2	(R-)
Sender	3	(T+)
Sender	4	(T-)
	5	Schirmung

# Terminalanschluß (DÜE)

(RS-232-C/V.24, 25/9-polige Sub-D Buchse/Stecker oder Rj-45)

Richtung	Pin Nr			ITU-T V.24 Bezeichnung	Beschreibung
	9-pol.	25-pol.	8-pol.		
I	3	2	6	103	TD/Transmitted data
O	2	3	5	104	RD/Received Data
I	7	4	8	105	RTS/Request To Send
O	8	5	7	106	CTS/Clear To Send
O	6	6	1	107	DSR/Data Set Ready
-	5	7	4	102	SG/Signal Ground
O	1	8	2	109	DCD/Data Carrier Detect
-	-	9	-	-	PWR +12V
-	-	10	-	-	PWR -12V
I	4	20	3	108/2	DTR/Data Terminal Ready

I = Eingang, O = Ausgang des MM-14

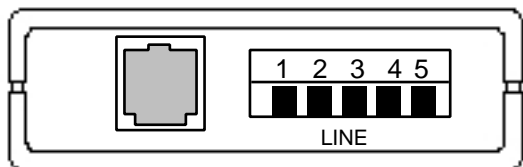

Spannungs-  
versorgungs-  
Anschluß  
PS-8

Leitungsanschluß  
5polige  
Schraubklemme

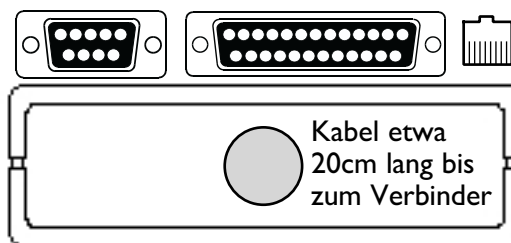

RS-232-C/V.24  
9-/25-poliger D-Sub  
Stecker oder Buchse  
8-poliger RJ-45 Stecker

# Leitungsanschluß

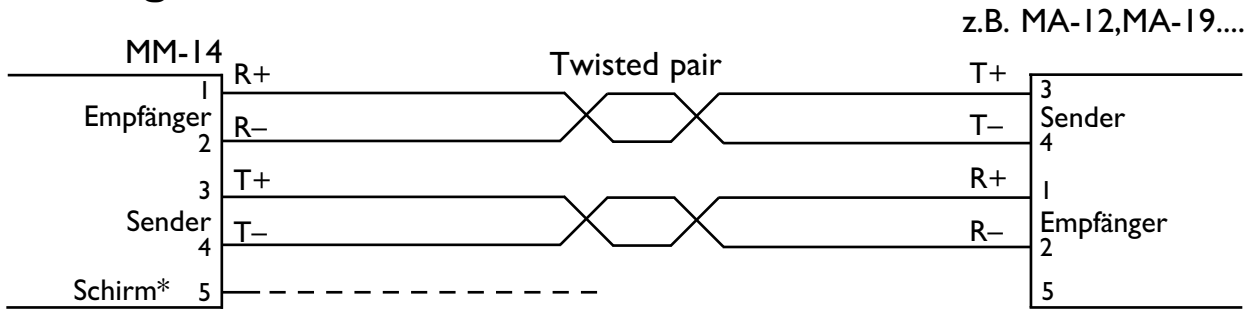

\* Bei Verwendung von abgeschirmten Kabeln den Schirm nur auf einer Seite anschließen um Erdströme zu vermeiden

## Übertragungsweiten 10 mA, WI (Schnittstelle 2)

Kabel	Übertragungsraten Bit/s						
	600	1 200	2 400	4 800	9 600	19 200	38 400
42pF/m 0,3 mm <sup>2</sup>	18 000 m	12 000 m	8 000 m	5 000 m	2 500 m	1 000 m	500 m

## Tips

Das MM-14 besitzt die selbe Leitungsschnittstelle wie alle anderen Westermo Produkte mit der  $\pm 10$  mA symmetrischen Stromschleife.

Die RS-232/V.24 Schnittstelle des MM-14 kann als DÜE (Datenübertragungseinheit) oder DEE

(Datenendeinrichtung) über Steckverbinder im inneren des MM-14 konfiguriert werden. Dadurch kann das gleiche Schnittstellenkabel bei DEE und DÜE Anwendungen benutzt werden.

Sollten Probleme bei der Einstellung des MM-14 auftauchen, können folgende Hinweise hilfreiche sein.

Eine gute Testmöglichkeit für das MM-14 ist einen Loop-Back Test durchzuführen. Verbinden sie T+ mit R+ und T- mit R-. Verbinden sie den RS 232/V.24 Anschluß mit einem Terminal somit sollten die abgeschickten Daten am Terminal sichtbar werden. Ist dieser Test erfolgreich, verbinden Sie die zweite Einheit und machen Sie eine Schleife zwischen RD (Received Data) und TD (Transmitted Data), das Ergebnis sollte das gleiche sein.

## Block diagram

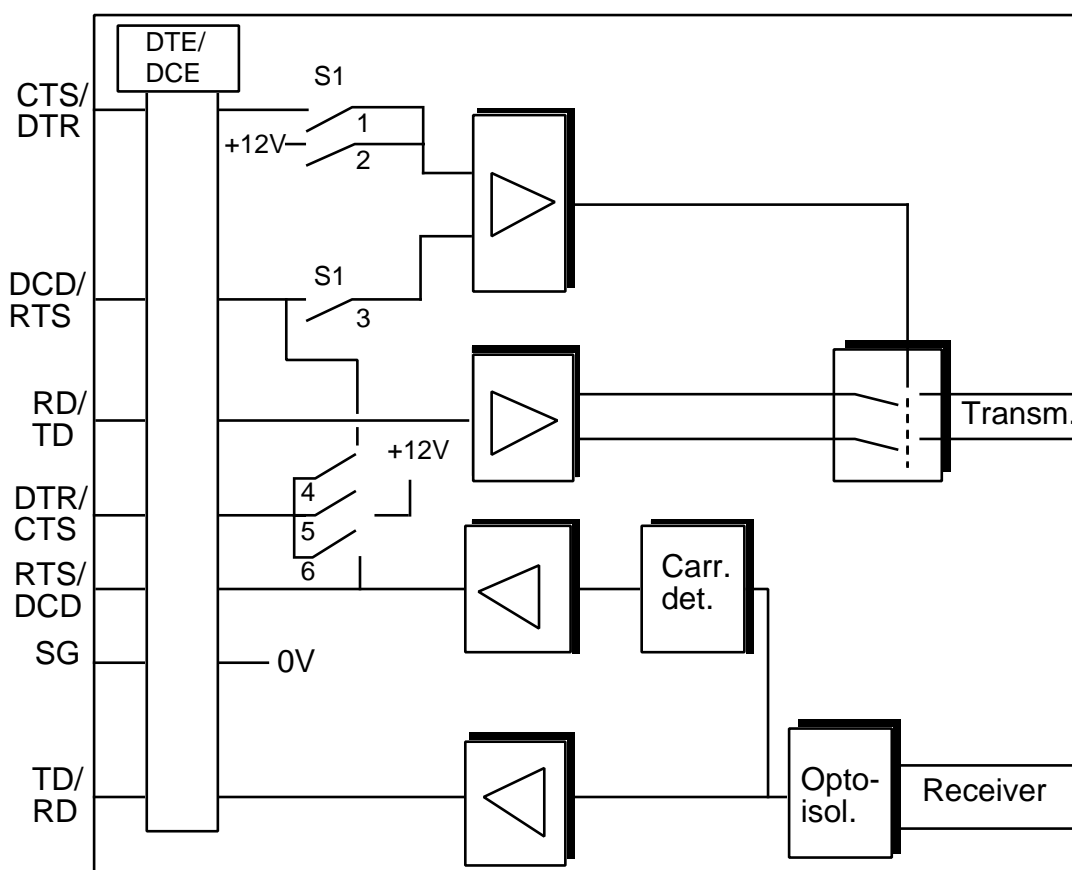

Westermo Teleindustri AB • SE-640 40 Stora Sundby, Sweden  
 Phone +46 16 42 80 00 Fax +46 16 42 80 01  
 E-mail: [info@westermo.se](mailto:info@westermo.se) • Westermo Web site: [www.westermo.se](http://www.westermo.se)

### Subsidiaries

Westermo Data Communications Ltd  
 Unit 14 Talisman Business Centre • Duncan Road  
 Park Gate, Southampton • SO31 7GA  
 Phone: +44(0)1489 580 585 • Fax: +44(0)1489 580586  
 E-Mail: [sales@westermo.co.uk](mailto:sales@westermo.co.uk) • Web: [www.westermo.co.uk](http://www.westermo.co.uk)

Westermo Data Communications GmbH  
 Goethestraße 67, 68753 Waghäusel  
 Tel.: +49(0)7254-95400-0 • Fax: +49(0)7254-95400-9  
 E-Mail: [info@westermo.de](mailto:info@westermo.de) • Web: [www.westermo.de](http://www.westermo.de)

Westermo Data Communications S.A.R.L.  
 9 Chemin de Chilly 91160 CHAMPLAN  
 Tél : +33 1 69 10 21 00 • Fax : +33 1 69 10 21 01  
 E-mail : [infos@westermo.fr](mailto:infos@westermo.fr) • Site WEB: [www.westermo.fr](http://www.westermo.fr)

*Westermo Teleindustri AB have distributors in several countries, contact us for further information.*